

AMP[®] Lighting

AMP[®] Low Voltage Landscape Lighting
3" Well Light
AWL-510 Series

Help Hotline:

1-813-978-3900 • Mon-Fri 8am-8pm • Sat-Sun 10am-6pm (EST)

www.AMPLighting.com

 **Important Safety Instructions: Read Before Installation**

This luminaire is intended for installation in accordance with local codes and the National Electric Code (NEC). Failure to adhere to these codes and instructions may result in serious injury, property damage and void the warranty.

These instructions do not intend to cover all variations in installation, operation maintenance or mounting situation.

1. Make sure that the power is turned OFF before installing or servicing this luminaire.
2. Warning: risk of electrical shock. Install all luminaires 10 feet (3.05M) or more from pool, spa or fountain.
3. This luminaire is intended to be used only with a power supply (transformer) rated maximum of 300 watts (25 AMPS) at 15 volts.
4. Wiring connections must be made with wire connectors that is suitable for outdoor use.
5. Position the low voltage wire and wire connector so that it is located within 6 inches (15.2 cm) from a building structure, a luminaire, or fitting.
6. The main low voltage cable is intended for shallow burial - less than 6 inches (152 mm)
7. If additional lengths of low voltage cable is required, please contact www.AMPlighting.com or call 1-813-978-3900.

SAVE THESE INSTRUCTIONS

Package Contents

- A. (1) Luminaire
- B. (1) PVC Tube

Product Dimensions

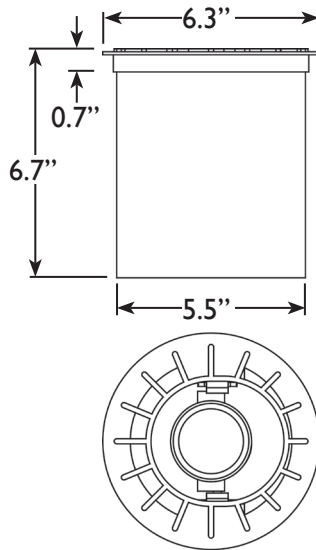

AMP[®] AMP[®] 3" Well Light AWL-510 Series

1 Dig Hole

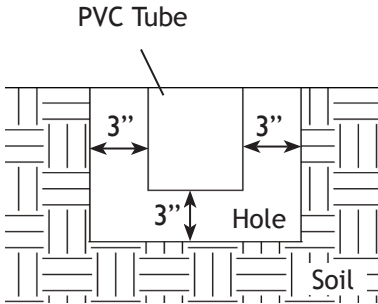

Dig hole on the ground. Make sure there are approximately 3" spaces surrounding the PVC tube for pea gravel or sand.

2 Wire Connections

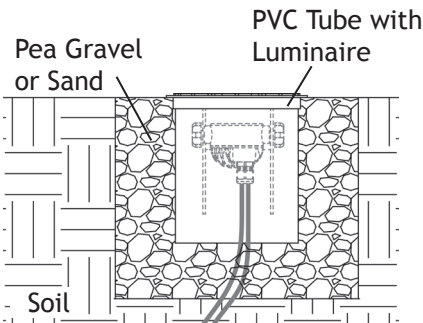

Place luminaire onto PVC tube. Pass luminaire pigtail through PVC tube.

Strip two leads from luminaire pigtail. Using two wire connectors, sold separately, connect leads from luminaire to main low voltage supply cable leads.

3 Fill Pea Gravel or Sand

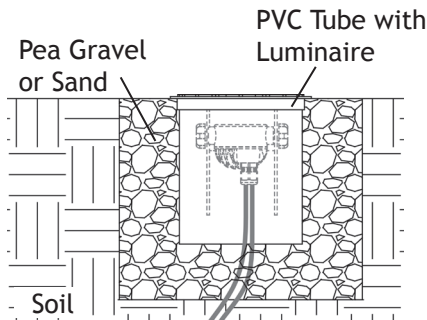

Install the PVC tube with luminaire in hole and fill hole with pea gravel or sand.

Adjust Position of Light and Change Optics

3 Remove Housing

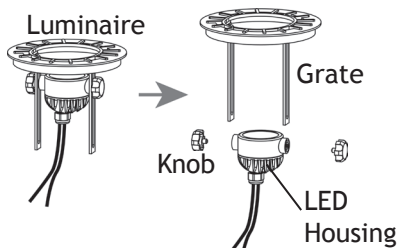

To Adjust Position of Light:
Loosen knobs. Adjust LED housing to desired position. Tighten knobs, and replace luminaire into PVC tube.

To Change Optics:
Loosen knobs, remove LED housing from holder.

5 Remove Cover

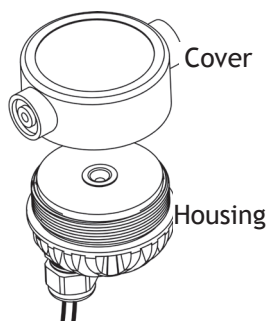

Unscrew cover and remove it from housing.

6 Replace Optic

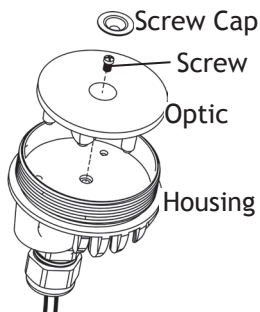

Remove screw cap at the center of optic. Unscrew screw, remove optic from luminaire.

Put new optic to luminaire. Reverse Steps 6 through 4 to reinstall removed parts.

INSTALLATION & MAINTENANCE GUIDE

AMP[®] AMP[®] 3" Well Light
AWL-510 Series

AMP[®] Lighting

Help Hotline:

1-813-978-3900 • Mon-Fri 8am-8pm • Sat-Sun 10am-6pm (EST)

Specifications and product details subject to change without notice.
© Copyright 2014, AMP[®] Lighting, Lutz FL USA 33549 • All rights reserved.
customersupport@AMPlighting.com • 813.978.3900

www.AMPlighting.com

is-awl-510-ver2